





## HAKKIMIZDA

EMOKON ELEKTRİK OTOMASYON SAN.TİC.LTD.ŞTİ. 2008 yılında endüstriyel otomasyon, kontrol sistemleri,konusunda hizmet vermek üzere kuruldu. Deneyimli kadrosunun sektörel tecrübesini teknolojiyi yakından takip etme duyarlılığı ile birleştiren firmamız faaliyetlerini doğrusal bir artış grafiği ile sürdürmektedir. Bu alanda yurt içi ve yurt dışında birçok projeye imza atmış olmanın haklı gururunu yaşamaktadır.

### HEDEFİMİZ

Sektöründe standartları belirlemek başta tedarikçileri ve müşteri memnuniyeti doğrultusunda zirvedeki yerini almaktır.

Şirketimiz,  
Elektrik Teknik Malzeme Satış hizmetlerini vermektedir.  
Endüstriyel Makine Otomasyonları  
PLC Sistemleri Konfigürasyon Ve Programlama  
SCADA Sistemleri Konfigürasyon Ve Programlama  
Montaj Ve Devreye Alma  
Makine Modifikasyon Uygulamaları  
Teknik Hizmet

Yetkili Bayilikler & Çözüm Ortakları



**ABB**

**Schneider**  
Electric

**SIEMENS**

**tp electric**  
industrial plugs & sockets

**Klemsan**<sup>®</sup>

**ORTAC**<sup>®</sup>

**ONKA**<sup>®</sup>

**SCHRACK**  
TECHNIK

**finder**<sup>®</sup>

**EAE**  
ELEKTROTEKNIK

**TONGUN**<sup>®</sup>

**tekpan**  
ENDÜSTRİYEL PANO & KABİN

**EMAS**<sup>®</sup>

**E/NTES**

**Safak**  
ŞAFAK ELEKTRİK MALZ.TİC.LTD.ŞTİ

**ETK**

**ÜNTEL**

**PAMUKKALE KABLO**

**HES**  
KABLO

**öznur kablo**

**LOOBAR**  
ELEKTRİK DAĞITIM VE EK ÇÖZÜMLERİ

**MW**  
MEAN WELL

**GEMO**<sup>®</sup>

**TECO**

**Pelsan**

**MAKEL**<sup>®</sup>

**DELTA**

**Raychem**<sup>®</sup>

**mesan**<sup>®</sup>  
Mesan Elektrik Müessesilik ve San. Ltd. Sti.

**General Electric**

**ENDA**

**Autonics**

**FLUKE**<sup>®</sup>



ACS550



ACH550



ACS310



ACS800



ACS850



AF Serisi Kontaktörler



PSR Soft Starter



MS116 - Motor Koruma Şalteri



A1N-Termik Şalter



SH201



SH202



SH203

Klemens, aksesuarlar, elektronik ürünler, otomasyon, reaktif güç kontrol rölesi, enerji analizörü, multimetreler, koruma kontrol röleleri, sinyal dönüştürücüler

**Klemsan®**



PLC 24V



FT NAM



CT3 AC LP



LSK 6



DM 22-K-5



Etor

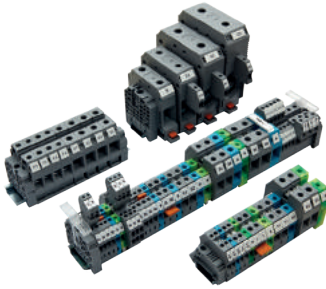

AVK Serisi Klemans

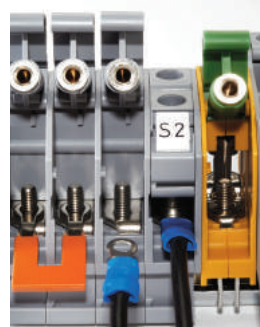

PB Kesit



PYK Grup

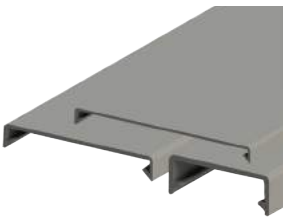

Kapaklar

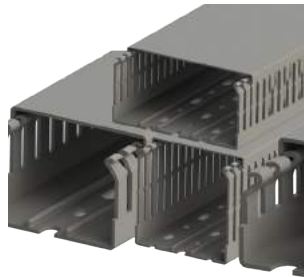

Slot

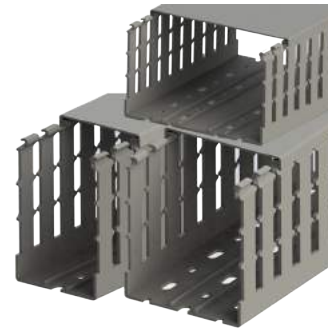

Kalın Slot



Harici Telefon Kabloları, Dahili Telefon Kabloları, Elektronik Kontrol Kabloları, Coaxial Kablolar, Data / LAN Kabloları, Fiber Optik Kablolar'ın üretimi



Elektronik Kontrol



Havai Tel



Harici Havai



Kumanda Kablosu



Yangın İhbar Kablosu



Kontrol



Coaxial



CAT5 Data



CAT6 Data



Fiber



Fiber 2



Havai Fiber





Çok Kontaklı Prizler



Çok Kontaklı Fişler



Yüksek Akım Fişleri



Yüksek Akım Prizleri



Ev - Büro Fişleri



Alüminyum Buat & Kombinasyon



Çocuk Korumalı Grup Prizler



Otomat Kutuları



Mandallı Alüminyum Buat

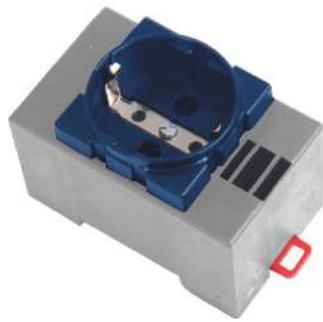

Monofaze Ray Priz



Kombinasyon Kutuları



CEE Norm



1 - W Otomat



3 - W Otomat



LC1D Kontaktör



K - Kontaktör



Sessiz Kontaktör



Motor Koruma Őalteri



Motor Koruma Őalteri  
Termik Manyetik



Freqans Sürücüler



Motor Sürücü



Kumanda Butonu





1 - W Otomat

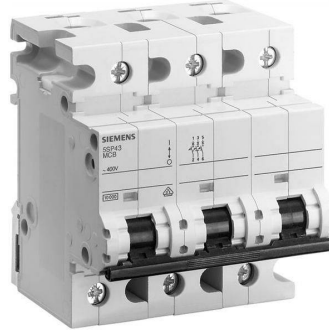

3 - W Otomat



Sirius Kontaktör



Kontaktör



Motor Koruma Őalteri



Sirius Motor Koruma Őalteri



Motor Sürücü



DC Sürücüler



Motor Hız Kontrol Sürücüler



Sinamics Sürücüler



Kumanda Butonları



Sinyal Lambaları



Kumanda Kutuları



Pedallar



Sınır Şalterler



Asal Siviçler



Pako Şalterler ve Kutuları



Işıklı İkazlar



Motor Koruma Şalterleri



Seviye Kontrol Flatörleri



Endüstriyel Tip Röleler-Soketler



Elektronik Röleler



Güvenlik Grubu Ürünleri



Vinç Grubu Ürünleri



Asansör Grubu Ürünleri



Röle Soketi



Elektromekanik Röle



Darbe Akım Rölesi



Minyatür Pcb Röle



Röle Soketi



İnce Solid Röle



Termistör Röle



Zamanlayıcı Modül



Voltaj Zamanlayıcı Modül



Minyatür Güç Rölesi



Soket Tipi Zamanlayıcı



Minyatür Zamanlayıcı

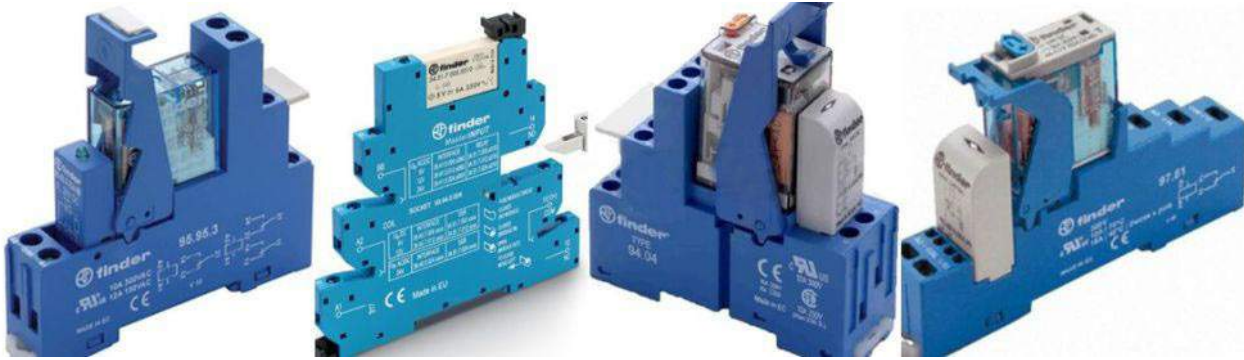

Röle Çeşitleri



RT424730 Röle



24VDC Röle



25A 260V Röle



UL CSA Röle



PT Standart Röle



G2RV Slim Röle



Ray Tipi Uzun Soket



RT16016 Klips



Ray Tipi Vidalı Soket



Ray Tipi Vidalı Soket



Ray Tipi Soket



Pcb Tipi Soket



Röle+Vidalı Soket



Fanlar ve Aksesuarlar



SER VO Motor ve Sürücüler



SG2 Serisi Akıllı Röle



TP03 Serisi PLC



AP Serisi PLC



SAMKOON (HMI)  
Dokunmatik Ekran



Semaphore RTU Uzaktan  
Erişim Üniteleri



Güç Kaynağı



JNHI Serisi Orta  
Gerilim Sürücüsü



MVC Serisi  
Orta Gerilim Soft Starter



F510 Serisi



A510 Serisi



N3 Serisi



L510 Serisi



S310 Serisi



Dahili Zaman Röleli Sıcaklık Kontrol Cihazı

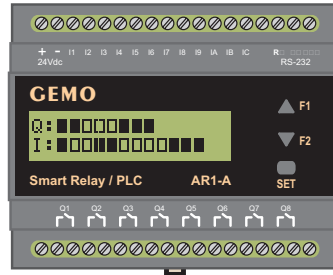

Ladder Logic Akıllı Röle



Profil (Adım) Kontrol Cihazı



Dahili Zaman Röleli Sıcaklık Kontrol Cihazı



Ekonomik Seri ON-OFF Sıcaklık Kontrol Cihazı

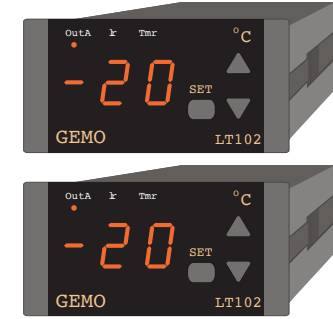

Isıtma/Soğutma Fonksiyonlu ON/OFF Sıcaklık Kontrol Cihazı



Universal Controller Indicator



Sayıçılar



Dijital Zaman Röleleri



Ekonomik Seri Dijital "ON DELAY" Zaman Röleleri



Analog Termostatlar / Zaman Röleleri

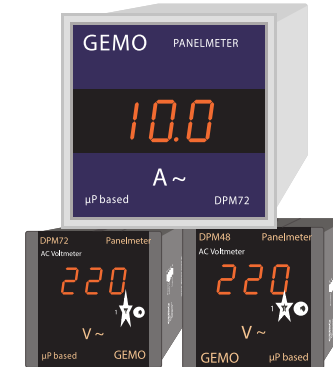

Panelmetreler



İki Baralı Dağıtıcılar



Bakır Nötr Toprak Baraları



100-500 Amper Ek Klemensleri



1 Faz Kompakt Dağıtıcılar



Erflex İzoleli Esnek Baralar

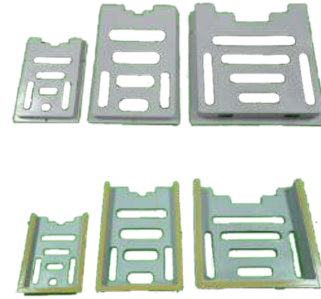

Proje Cepleri

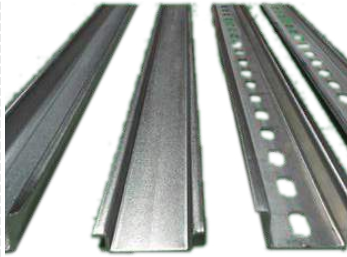

W-Otomat Rayları



Isiso Mini Ray Tipi Smps



Baraya Montaj Kesiciler



Filtreli Panjurlar



Fan Setleri



Tarak İzolatörler



Yuvarlak Tip  
Kablo Pabuçları



H Tipi Klemensler  
Kablo Pabuçları



İzoleli Kablo Yüksükleri  
Alman Renk Normu



İzolesiz Kablo  
Yüksükleri



Şafak Yuvarlak Tip  
İzoleli Kablo Uçları



Dişi Faston Tip - İzoleli  
Kablo Uçları



Montaj  
Rayları



Ekko Serisi - Paslanmaz  
Çelik Kablo Bağları



Mekanik  
El Aletleri



Hidrolik  
El Aletleri



Hidrolik Pompa ve  
Aksesuarları



Elektrikli  
Şarjlı Aletler





Enerji Kalitesi



Ölçme



Kompanzasyon



Şönt Reaktörler



Uzaktan İzleme



Veri Toplayıcılar



Koruma & Kontrol



İzolasyon Trafoları



Kumanda Trafoları



Bağlantı Ürünleri



Vidalı Klemensler

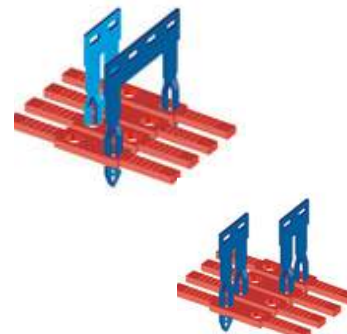

Klemens Aksesuarları



Tesisat Kabloları



Alçak Gerilim Kabloları

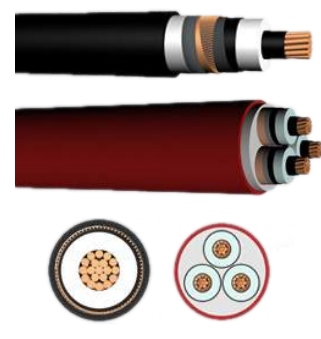

Orta Gerilim Kabloları



Yüksek Gerilim Kabloları

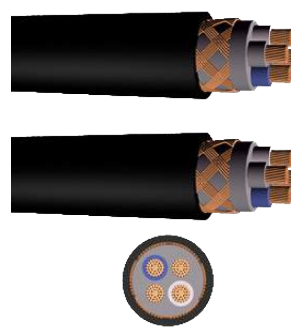

Gemi Kabloları



Havai Hat Güç Kabloları



Havai Hat Güç Kabloları

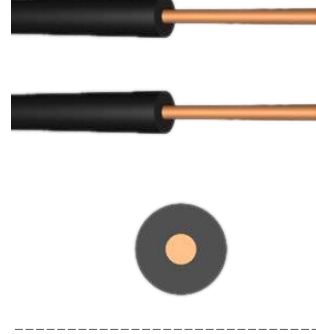

Halojensiz Tesisat Kabloları

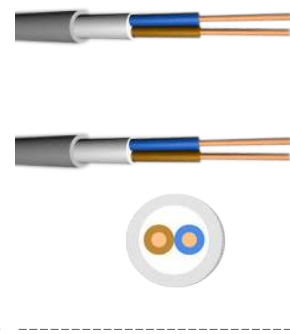

Halojensiz Tesisat Kabloları

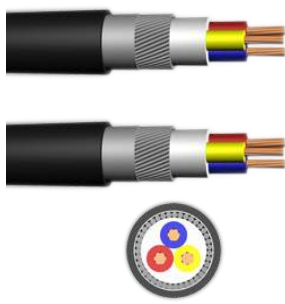

Maden Ocakları Kabloları



PVC Granül

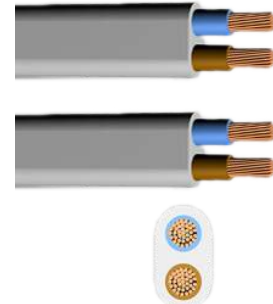

Tesisat Kabloları



Gemi Kabloları



Off-Shore Kabloları



Off-Shore Kabloları



Endüstriyel Kabloları

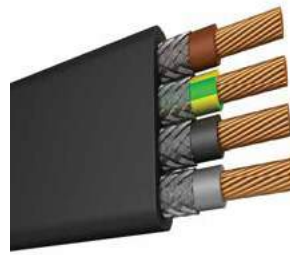

Endüstriyel Kabloları



Maden Kabloları

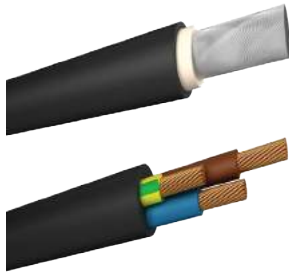

Demiryolu Kabloları

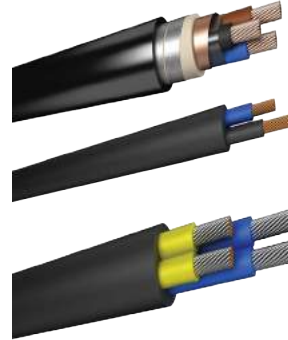

Demiryolu Kabloları

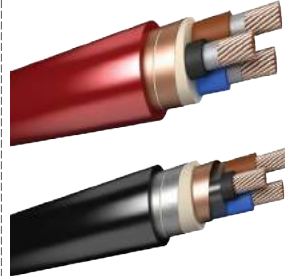

Demiryolu Kabloları



Hava Alanları Pist Kabloları



PAMUKKALE KABLO

Harmonize Kablolar, Halojensiz Alev Geciktiricili Kablolar, Orta ve Yüksek Gerilim Enerji Kabloları, PVC Yalıtkanlı Alçak Gerilim Enerji Kabloları, XLPE Yalıtkanlı Alçak Gerilim Enerji Kabloları

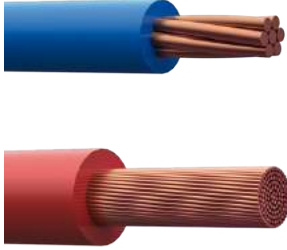

Tek Damarlı (Pvc)  
Tesisat Kabloları

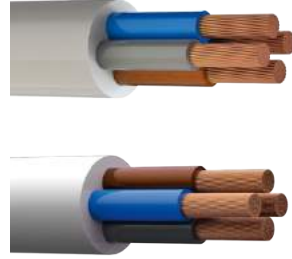

Pvc Fleks  
Kablolar

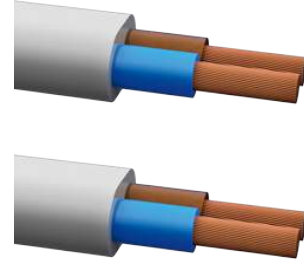

Pvc Yassı Fleks  
Kablolar

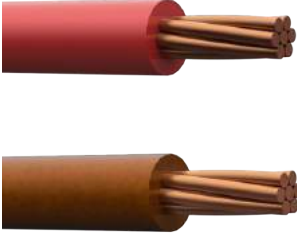

Tek Damarlı Halojensiz  
Tesisat Kabloları

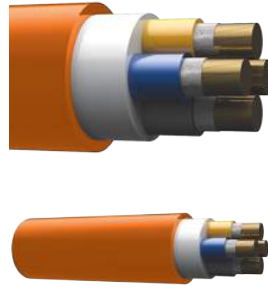

Aleve Dayanıklı Alçak  
Gerilim Enerji Kabloları



Tek Damarlı Orta  
Gerilim Kabloları

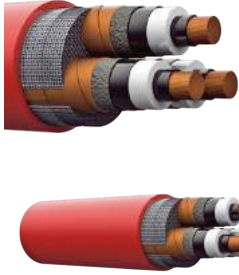

3 Damarlı Orta  
Gerilim Kabloları



Suya Dayanıklı Orta  
Gerilim Kabloları

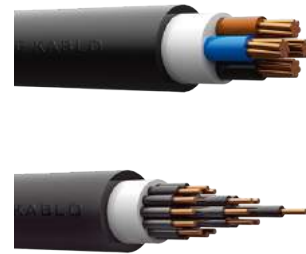

PVC İzoleli Yer Altı Alçak  
Gerilim Enerji Kabloları

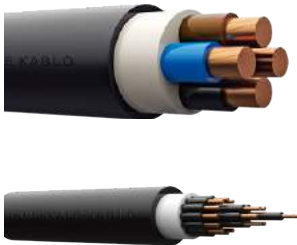

PVC İzoleli Yer Altı Alçak  
Gerilim Enerji Kabloları

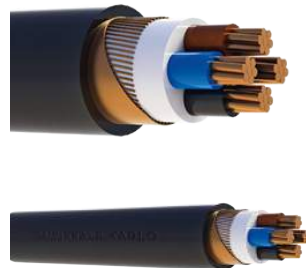

XLPE İzoleli Bakır Ekranlı  
Alçak Gerilim Enerji Kabloları

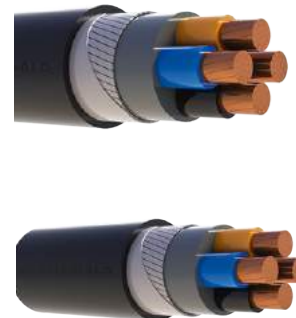

XLPE İzoleli Yassı Çelik Tel  
Zırlı Alçak Enerji Kabloları





IP68 Etanj Tip Kablo Rakorları (somunlu)



BWL Zırlı Piriç Kablo Rakorları



Geçmeli Tip Rakorlar



Polyamid T - Y Dağıtıcı Elemanları



Minigland



Kablo Rakorları & Aksesuarları



Çelik Zırlı Spiral Borular



Polyamid Spiral Borular



Piriç Rekor & Körtapa



Polyamid & Metal & PVC Spiral Boru ve Aksesuar



Ankastre Dağıtım



2'li Sayaç Kutusu



4'lü Sayaç Kutusu



Ankastre Sayaç Panoları



Ankastre Bantlı Sayaç Panoları



Elektrik Panosu



İki Ön Kapılı Pano Aksesuarları



Marina Kutusu



Standart Tip Polyester Panolar



Saha Dolabı Kaideli Açık Kapak





X Serisi  
Paslanmaz Kabinler



T Serisi  
Terminal Kutuları



S Serisi Dikili Tip  
Modüler Kabinler



K Serisi  
Kumanda Konsolları



Panelmaster  
Elektrik Panoları



H Serisi Harici  
Tip Kabinler



M Serisi Harici Tip  
Monoblok Kutular



B Serisi Bara  
Düzenekleri



D Serisi Dikili Tip  
Modüler Kabinler



E Serisi İç  
Tesisat Kabinleri



O Serisi  
Kutular



M Serisi  
Monoblok Kutular



METAL KABLO TAŞIMA SİSTEMLERİ

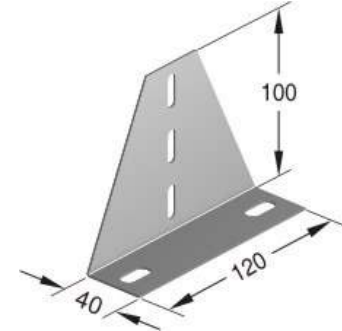
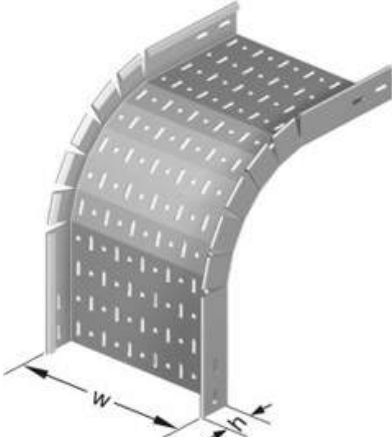
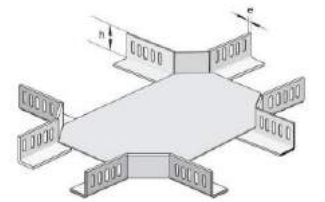
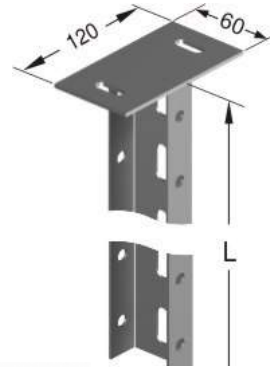





ELEKTRİK MALZEMELERİ





# ÜÇ FAZLI MOTORLARDA ANMA AKIMINA GÖRE SİGORTA VE İLETKEN SEÇİMİ

Motor Anma Gücü		Cos Q	Verim	Motor Anma Akımı (A)	Sigortalar		Motor Anma Akımı (A)	Sigortalar		Motor Anma Akımı (A)	Sigortalar		Bağlantı Kablosu NYY NYCY mm2
kW	PS				Direkt (A)	Y/Δ (A)		Direkt (A)	Y/Δ (A)		Direkt (A)	Y/Δ (A)	
0.25	0.34	0.7	62	1.4	4	2	0.6	2	2	0.8	2	2	4x2.5
0.37	0.5	0.72	64	2.1	4	2	0.9	2	2	1.6	4	2	4x2.5
0.55	0.75	0.75	69	2.7	4	4	1.2	4	4	1.6	4	2	4x2.5
0.75	1	0.8	74	5.4	6	1	1.5	4	4	2	4	4	4x2.5
1.1	1.5	0.8	77	4.4	6	6	2	4	4	2.6	4	4	4x25
1.5	2	0.83	78	6	16	10	2.6	4	4	3.5	6	6	4x2.5
2.2	3	0.84	81	8.7	20	16	3.7	10	6	5	10	6	4x25
3	4	0.84	81	11.5	20	16	5	10	10	6.6	16	10	4x2.5
4	5.4	0.84	82	14.7	25	20	6.4	16	10	8.5	20	16	4x2.5
5.5	7.5	0.85	83	19.8	35	25	8.5	20	16	11.5	25	20	4x2.5
7.5	10	0.86	85	26.5	50	35	11.5	25	20	15.5	35	25	4x4
11	15	0.86	87	39	63	50	17	35	25	22.5	35	35	4x6
15	20	0.86	87	52	50	63	22.5	35	35	30	50	35	4x6
18.5	25	0.86	88	62	100	80	27	50	35	36	63	50	4x10
22	30	0.87	89	74	100	80	32	63	50	43	63	50	4x10
30	40	0.87	90	98	125	100	43	63	50	57	80	63	4x16
37	50	0.87	90	124	200	160	54	80	63	72	100	80	3x25+16
45	61	0.88	91	147	225	200	64	100	80	86	125	100	3x35+10
55	75	0.88	91	180	250	225	78	125	100	104	60	125	3x50+25
75	100	0.88	91	246	350	250	108	160	125	142	200	100	3x70+35
90	123	0.88	92	-	-	-	127	200	100	169	225	200	3x95+50
110	150	0.88	92	-	-	-	154	225	200	204	250	225	3x120+70
132	180	0.88	92	-	-	-	182	250	225	243	300	250	3x120+70

GÜÇ (Kw)	0.6/1 kV YALITKANLI KABLOLARIN STANDART GÜÇLERİ TAŞIYABİLECEKLERİ MAX. UZAKLIK (m)															
	1.5	2.5	4	6	10	16	25	35	50	70	95	120	150	185	240	300
2.5	103	169	271	404	675	1063										
3	87	142	227	339	567	892	1391									
3.5	73	120	192	287	480	756	1180									
4	65	106	169	253	423	666	1038									
4.5	58	94	51	226	378	595	927	1266								
5	51	84	135	202	337	531	828	1130								
6	43	70	112	168	280	442	689	940	1247							
7	36	60	96	143	240	378	590	805	1067							
8	32	52	84	125	210	330	515	703	932	1301						
9	28	46	74	111	186	293	457	625	828	1155						
10	25	42	67	101	168	265	414	565	750	1045						
12	21	35	56	84	141	223	347	474	630	878	1168					
14	18	30	49	73	123	194	302	413	547	764	1014					
16		26	42	62	105	165	257	351	466	650	863	1053				
18		23	37	56	94	148	231	316	419	585	777	948	1119			
20		21	34	51	85	135	210	287	381	532	706	862	1017			
22			30	45	76	120	288	256	340	475	630	769	907	1072		
25			27	40	67	106	165	226	299	418	555	677	799	944	1156	
30				33	56	89	139	189	251	351	466	569	671	793	971	1124
35					48	75	117	161	213	297	395	482	569	672	823	952
40					42	66	103	141	187	262	348	425	501	592	425	838
45					58	91	124	165	231	306	374	442	522	639	739	
50					53	82	113	149	209	277	338	400	472	578	669	
55					48	74	102	135	188	250	305	361	426	522	604	
60						68	94	124	173	230	281	332	392	481	556	
70						58	80	106	148	197	241	284	336	411	476	
75						55	75	99	139	185	225	266	314	385	446	
80							70	93	130	172	210	248	293	360	416	
90							62	82	115	153	187	220	261	319	369	
100								74	103	138	168	198	234	287	332	
110								68	94	126	153	181	214	262	303	
130								80	106	129	153	181	221	256		
133								78	104	127	149	177	216	250		
150									92	112	132	156	192	222		
160									86	105	124	146	179	208		
180										93	110	130	160	185		
200											99	117	144	166		
205											97	114	140	162		
230												102	125	145		
270													106	123		
280														119		
290														114		
300														111		
305														109		

Cos φ = 0.9 olarak alınmıştır



**EMOKON**  
**elektrik**

EMOKON ELEKTRİK MAKİNA OTOMASYON KONTROL SİSTEMLERİ SAN. TİC. LTD. ŞTİ.  
1354. Caddesi (Eski 21 cad.) Ankara İvedik Organize Sanayi  
Bölgesi No:39 İvedik Mh., 06105 Ankara, Türkiye  
Tel : +90 312 354 50 07 (pbx) - Fax: +90 312 354 50 17  
Web: www.emokon.com.tr - Mail: emokon@emokon.com.tr



**KOSGEB**  
www.kosgeb.gov.tr

Basım Yeri: ANALİTİK REKLAM MEDYA  
BİLGİSAYAR TURİZM SAN. TİC. LTD. ŞTİ.  
Basım Yeri Telefon: 0312. 354 87 04  
Basım Yeri Adresi: İvedik O.S.B. Ağaç İşleri  
San. Sit. 21. Cad. 1373. Sokak No:32 Kat:1  
Yenimahalle / ANKARA  
Basım Adet: 2.500  
Basım Tarihi: 1.3.2016

